

5

PROPERTIES OF COMMERCIAL POLYMERS

PROLOGUE

- Commercial Polymers
- Biomedical Polymers

▶ POLYETHYLENE

Polyethylene is a commonly used polymer. It was first produced in England in 1933 by polymerising the ethylene monomer by the Imperial Chemical Industries, Ltd. (ICI).

It is the simplest hydrocarbon polymer and has the following structure :

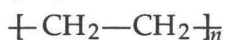

For the production of a polyethylene, ethylene monomer can be prepared either by the dehydration of ethanol or by the hydrogenation of acetylene. Sometimes, it is produced from petroleum products by the cracking process. In cracking process, saturated hydrocarbons such as ethane or propane undergo catalytic degradation and dehydrogenation, producing ethylene. At room temperature, ethylene is a gas and its boiling point is -104°C .

There are various varieties of polyethylene, such as :

- (a) Low-density (Branched) Polyethylene.
- (b) High-density (Linear) polyethylene
- (c) High and ultra-high molecular weight polyethylene
- (d) Cross-linked polyethylene

(a) Low-density (Branched) Polyethylene

Branched polyethylene was the first commercial ethylene polymer, commonly designated as low-density or high pressure material. Low-density polyethylene consists of molecules with branches and is produced by the high pressure polymerisation of ethylene; using oxygen as the initiator. The reaction occurs at 1400 atm of pressure and in the temperature range of $180\text{--}250^\circ\text{C}$. Besides of oxygen, other initiators are peroxides, hydroperoxides, and azo compounds.

For the polymerisation techniques, ethylene is dissolved in the solvents employed benzene, chlorobenzene etc., and a true solution is prepared. Water or other liquid may be added to dissipate the heat of reaction.

To obtain good quality of physical properties of the product, balanced and continuous polymerization systems preferred. In continuous process, tubular reactors are used; which may have diameters of less than 1 inch and lengths upto 100 ft. The stainless steel tube is filled with water, and ethylene containing initiator and benzene is introduced. At one or more points along the entire tube, additional initiator and water or benzene can be injected to keep the initiator concentration more nearly constant throughout the reactor. At the far end of the reactor, about 10% ethylene is polymerized. Here the gas and liquid phases are removed continuously, the polymer is separated, and the ethylene is recycled after purification.

In bulk polymerisation process, a tower-type reactor is used. Ethylene containing trace quantity of oxygen is charged to the reactor at 1400 atmosphere at 190°C. The reaction is kept isothermal and carried to 10–15% conversion. The effluent from the reactor passes to a separatory vessel in which unconverted ethylene is removed for recycling. The molten polyethylene is chilled below its crystalline melting point and passed through the usual finishing steps.

Structure : Low density polyethylene melts at 110–125°C and is a partially 50–60% crystalline solid; with density in the range 0.91–0.94. While practically no solvent dissolves it at room temperature. It is soluble in many solvents at temperature above 100°C. Some of the useful solvents for polyethylene at high temperatures are carbon tetrachloride, toluene, decaline, trichloro ethylene and xylene. The dissolved polymer precipitates out as the solution cools down to room temperature.

As the low-density polyethylene consists of molecules with branches, this branching occurs during the process of polymerisation either by intermolecular or intramolecular chain transfer reactions as follows :

1. Intermolecular chain transfer

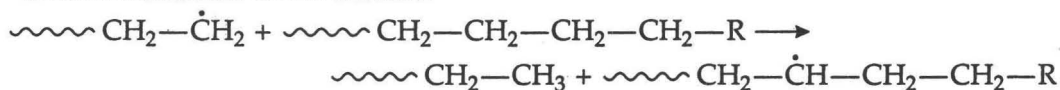

2. Intramolecular chain transfer

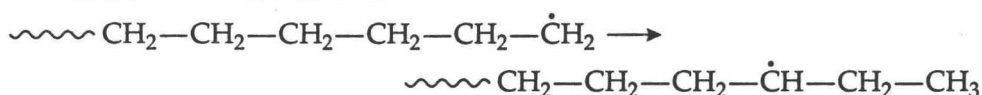

In the first case, the branches could be as long as the backbone chain itself, whereas, in the second case, the branches are much shorter in length.

Properties : The physical properties of low-density polyethylene are functions of three structural variables such as, molecular weight, molecular weight distribution or long-chain branching, and short chain branching.

Short-chain branching has a predominant effect on the degree of crystallinity and therefore on the density of polyethylene.

Actually these properties are influenced by total chain branching, but the number of long-chain branch points per molecule in polyethylene is too less than the number of short

chain branch points that the former can be neglected. Hence, the properties which depend on crystallinity, such as hardness, stiffness, chemical resistance, tear strength, softening temperature and yield point, increase with increasing density or decreasing amount of short-chain branching in the polymer, while toughness, permeability to liquids and gases, and flex life decrease under the same conditions.

As regarding molecular weight, if it increases, so do tear strength, tensile strength, impact strength, low-temperature toughness, softening temperature, and resistance to environmental stress cracking while melt fluidity, melt 'drawability', and coefficient of friction decrease. These properties are commonly compared on the basis of changes in melt index, which varies inversely with molecular weight.

The effect of long chain branching on the properties of polyethylene is generally evaluated in terms of the breadth of the molecular-weight distribution $\overline{M}_w / \overline{M}_n$. A decrease in $\overline{M}_w / \overline{M}_n$ causes a decrease in case of processing but an increase in toughness, tensile strength, softening temperature, impact strength, and resistance to environmental stress cracking.

The mechanical properties of low-density polyethylene are in between of rigid materials like polystyrene and limp plasticized polymers like vinyls.

Polyethylene has good toughness and pliability over a wide temperature range. Its density falls rapidly above room temperature; and resulting much dimensional changes which cause difficulty in some fabrication methods. Low crystalline melting point, *i.e.*, about 115°C, limits the temperature range of good mechanical properties.

The electrical properties of polyethylene are outstandingly good, which ranking next to those of polytetrafluoroethylene for high-frequency uses.

Chemically, polyethylene is an inert compound. At room temperature, it does not dissolve in any solvent. In benzene and carbon tetrachloride, it is slightly swelled. It has good resistance to acids and alkalis. At 100°C in sulphuric acid and hydrochloric acid in 24 hours, polyethylene is unaffected, while charred by concentrated nitric acid.

On exposure to light and oxygen, the polyethylene ages with loss of strength, tear resistance and elongation. This may be due to the point of attack which is the tertiary hydrogens on the chain at branch points.

Polyethylene also undergoes some cross-linking when heated at elevated temperature. Few plasticizers or other additives are compatible with polyethylene in amounts larger than 1% or so.

Applications : For many years, almost two-thirds of the low and medium density branched polyethylene produced has gone into film and sheeting uses. Over three-fourths of the polyethylene film produced goes into packing applications, including pouches, bags, and wrapping for produce, textile products, merchandise, frozen and perishable foods, and many other products. Other film uses include drapes and tablecloths. It is also used in agriculture such as, canal, tank and pond liners, green houses, ground covers etc. and in construction as moisture barriers and utility covering material.

Polyethylene is used as extrusion coating for packaging materials. Low-density polyethylene is inert to chemicals and resistance to breakage, these properties find used in

the manufacture of milk-type cartons for wide variety of foods and drinks. The non-polar nature of the polymer makes it ideal for providing insulations to electric cables.

Low-density polyethylene is also used in toys, various housewares, containers, lids, domestic water line connections, and several other purposes.

(b) High-density (Linear) Polyethylene

High-density linear polyethylene can be prepared by various methods such as, coordination polymerization of ethylene, polymerisation of ethylene with supported metal oxide catalysts, and radical polymerization of ethylene at extremely high pressures.

In coordination polymerisation of ethylene, a catalyst is used. The catalyst prepared as a colloidal dispersion by reacting an aluminium alkyl and TiCl_4 in heptane solvent. At relatively low pressure, ethylene is added to the reaction vessel at 50–75°C. After cooling the vessel, polymer is obtained as a powder or granules which is filtered and centrifuged off, washed and dried. At the end of the reaction, the catalyst is destroyed by using alcohol or water.

In another method, supported metal-oxide catalysts such as chromium, or molybdenum oxides, supported over alumina-silica bases is used. The ethylene is fed with a paraffin or cycloparaffin diluent, at 60–200°C and around 500 psi pressure. The polymer is recovered either by cooling or by solvent evaporation.

Structure : High-density linear polyethylenes are highly crystalline polymers containing less than one side chain per 200 carbon atoms in the main chain. Its density is in the range of 0.95–0.97 and melting point is above 127°C.

Properties : Linear polyethylenes are hard, stiffed and have higher crystallinity. They have higher melting point, greater tensile strength, good chemical resistance, low temperature brittleness, and low permeability to gases.

Applications : High density linear polyethylene is used in the manufacture of toys, containers, films, sheets, wire and cable insulation, extrusion coating, pipe, rotational molding, injection molding, crates, tubs, pails, caps, closures and several other household articles. Whenever high tensile strength and toughness are required, high-density linear polyethylene finds better use.

(c) High and Ultra-high Molecular weight Polyethylenes

The average molecular weight of high-density linear polyethylene is 100,000–200,000 whereas, high molecular-weight polyethylene has \bar{M}_w between 300,000 and 500,000. This polymer is widely used commercially. It has long-term stress retention, and improved environmental stress crack resistance, impact and tensile strength. High molecular weight polymer is used in the manufacturing of pipe, films, and large blow-molded containers.

Ultra-high molecular weight poly-ethylene consists of \bar{M}_w between 300,000 and 600,000. This polymer does not flow and melt in the normal plastic manner. It has exceptional impact resistance and abrasion quality. It is used in the high-wear resistance applications such as gaskets, conveyor-belt parts, valve seats etc.

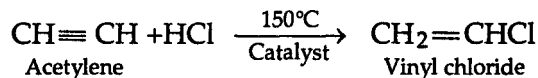

Polymerization : Over 80% production of polyvinyl chloride is obtained by suspension polymerization. While small amounts are produced by solution, bulk and emulsion polymerization.

In emulsion systems redox initiators are used. It is performed at low temperature, *i.e.*, about 20°C.

In bulk and suspension polymerization, azo compounds are used as initiator. It is carried out at higher temperature, *i.e.*, 50–80°C.

Structure : The polymer polyvinyl chloride is widely used as plastic and, to a much smaller extent as fibres. The trade name of this polymer is known as 'the vinyls' or vinyl regions. The polymer has the following structure :

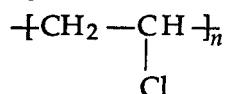

Polyvinyl chloride does not consist of a complete regular structure, therefore, it is called a partially syndiotactic material. It has low crystallinity. The polymer molecule is complicated by the possibility of having either linear or only branched structure. It is insoluble in water, hydrocarbons, vinyl chloride and alcohols : It is unaffected by acids and alkalis upto 20°C. It is soluble in ketones, chlorinated hydrocarbons, and mixture of acetone and carbon disulfide.

Stability : The polymer polyvinyl chloride is unstable to heat and light. On heating such polymer, loss of a chlorine atom takes place, which causes reduction of the stability of the C—Cl bond.

In the presence of oxygen, chain reactions are accelerated, and ketonic structures 'are formed in the chain. The stability of polyvinyl chloride can be stabilized by adding some stabilizers. To improve heat and light stability, metallic salts of lead, cadmium, tin or barium are used. Salts of fatty acids, oxides or hydroxides are also found most effective stabilizers.

Plasticization : Polyvinyl chloride is a 'rigid vinyl' and called a horn-like material. It is difficult to process. It is, therefore, compounded with plasticizers. For plasticization, polyvinyl chloride is mixed with a few percent of plasticizer such as an epoxy resin to improve its impact resistance. Depending on the plasticizer quantity, fully rigid to fully flexible products can be achieved. Generally, the percentage of plasticizer is kept around 30% by weight of the polymer. The common plasticizers used for this purpose are tricresyl phosphate, dibutyl phthalate, dibutyl sebacate, tributyl phosphate, dioctyl phthalate, trioctyl phosphate, dioctyl sebacate and adipate, and polypropylene glycol esters etc.

Plastisols and Organisols : In some formulations, polyvinyl chloride is widely used, called plastisols and organisols. These are paste-like materials and are obtained by emulsion-polymerized polyvinyl chloride resin particles.

Plastisols are formed by dispersing polyvinyl chloride particles into plasticizers. Whereas organosols are obtained by dispersing polyvinyl chloride particles in a mixture of volatile organic liquid and plasticizers. The other ingredients present in plastisols and

organosols are colourants, surfactants, fillers, stabilizers, and blowing agents or gelling agents. The polymer particles do not dissolve in the liquids, but remain dispersed until the mixture is heated. At around 150°C to 200°C, polyvinyl chloride fuses with plasticizer and produces a cross-linked compound, as a final plastic object.

Applications : Polyvinyl chloride is the cheapest and single largest used plastic in the rigid field. About 40% of the production is employed in the pipes. It is used for electrical and telephone cables, sewer systems, water supply and distribution, agricultural irrigation, drain, waste and vent pipe, and chemical processing. It is also used in meat and food packaging, bottles, footwears, sport goods, toys, and other significant markets. About 30% of production of polyvinyl chloride is employed in building construction market, 12% for interior molding, gutters, window frames, about 5% for flooring, 7% for wire and cable insulation and 5% in upholstery, wall coverings, shower curtains, gaskets etc.

In polyvinyl chloride, the total chlorine percentage is about 56.8%. It can be further enhanced by dissolving it in an appropriate solvent such as chlorobenzene at 100°C. In this reaction, the chlorine replaces the hydrogen atoms in the —CH₂— units rather than in the —CH—Cl— unit of the molecule. The polymer thus obtained is called chlorinated polyvinyl chloride. This polymer is more resistant to acids and bases. The principal use of this polymer is in the manufacture of fibres, adhesives and coatings. The main disadvantage of chlorinated polymer is that it is slightly unstable in heat and light.

▶ POLYAMIDES

For synthetic polyamides, the word 'nylon' has been accepted as a generic term. There are different types of nylons, which are usually indicated by a numbering system. This number gives the number of carbon atoms present in the monomer molecules. Nylons synthesised from dibasic acids and diamines; and are designated by two numbers. The first number indicating the C atoms present in the diamine and the second representing the number of C atoms in the dicarboxylic acid. Thus, a polyamide obtained from hexamethylene diamine and adipic acid is written as nylon 6, 6. Nylon 6, 6 and nylon 6 are commercially great important polyamides.

The general structure of the melt polycondensation product of polyamide is as follows :

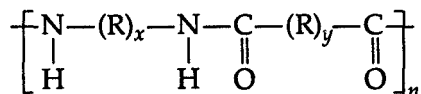

where R = —CH₂ or 

Properties : Nylons are used both, as plastics and as fibres. It has a high strength, toughness, elasticity and abrasion resistance. Although, plastic consists of its limit of use upto 125°C, even then, good mechanical properties are maintained upto 150°C.

The solvents phenols, cresols and formic acid dissolve the polyamides at room temperature. This polymer is slightly affected by strong acids. Above 130°C in the air polymer disappears its colours; and is degraded at higher temperatures. In the nylon polymer, the polar groups are present, hence its electrical uses are restricted to low

frequencies. The moisture acts as a plasticizer to increase the flexibility and toughness of the polymer. The melting point range of aliphatic nylons is between 250–300°C, whereas, aromatic nylons contain a very high melting point, *i.e.*, > 500°C. Recently, aliphatic nylons, having high melting points in the range of 435–450°C have been produced by the interfacial polycondensation of terephthalic dichloride with aliphatic diamines as follows :

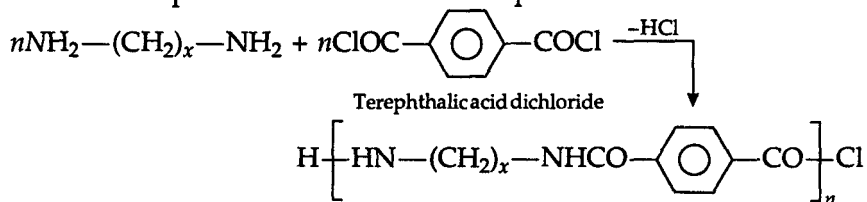

Aromatic polyamides are produced either by the self-condensation of aromatic amino acids or by polycondensation between aromatic diacid chlorides and aromatic diamines. In this case, polycondensations are carried out by melt, solution or interfacial techniques as follows :

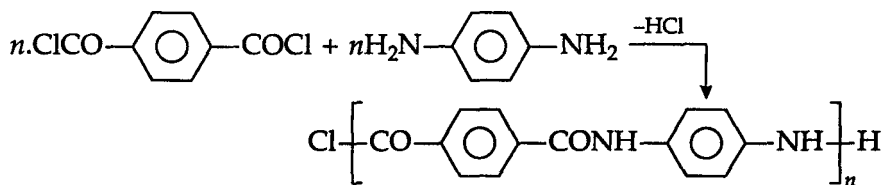
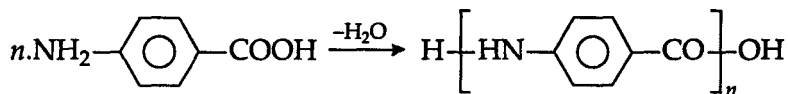

Fibre Applications : About 60% of nylon production is used as fibres, especially carpets. Another 20% of production is used for apparel, and only 10% is for tyre cord.

Plastic Applications : As the nylon is tough, stiffed and hard in nature, it is a good substitute of metal in bearings and gears. Slides, rollers and door latches are oftenly made by nylon. Cover of electrical wires, are also manufactured by nylon due to its electrical insulation and abrasion-resistant property.

Higher nylons, *e.g.*, 610, 612, 11 and 12, have comparatively lower stiffness and heat resistance than nylon-6 and 66; but have improved chemical resistance and lower moisture absorption. They are generally used as special plastics.

A number of other polyamides are manufactured to increase their use by improving their strength-molecular weight ratio, thus with increased stiffness, creep resistance, impact resistance and the reinforced grades plastics are prepared.

An aromatic polyamide made from dodecanedioic acid and bis-para-aminocyclo hexyl methane, (trade name : Dupont's Quiana), spun in trilobal form, is used in preparation of luxury dress apparels. Similarly, another aromatic nylon, Nomex, is highly nonflammable, and it is now developing many industrial applications, where heat resistance is required. Kevlar, which is a more readily crystallized polymer and oriented as can be inferred from its para structure, is important for its outstanding strength-weight ratio. The Kevlar cable can match the strength of steel at the same diameter and 20% of the weight.

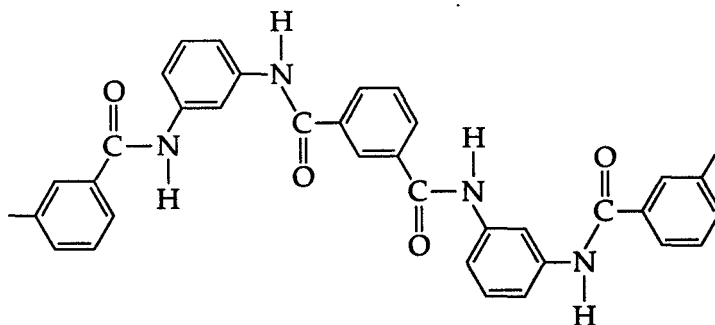

Nomex

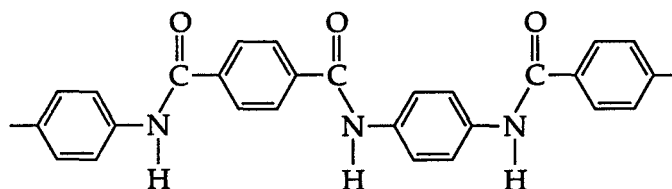

Kevlar

♦ POLYESTERS

In the early days, the polymer polyester was synthesized by a polycondensation reaction between an aliphatic dicarboxylic acid and diol. The resultant product was completely aliphatic polyester, with low melting point, *i.e.*, in the range of 50–80°C and high solubility. For a long time this linear aliphatic polyester was not of much industrial use. The aliphatic polyesters have the ester linkages with following structure :

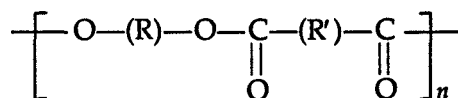

where R and R' are aliphatic $-\text{CH}_2-$. The problem of low melting point was overcome by introducing aromatic rings into the polyester chain and the following structure was obtained which consists of higher melting point, *i.e.*, 265°C :

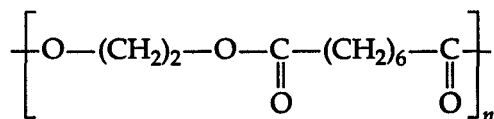

Aliphatic polyester (melting point 65°C)

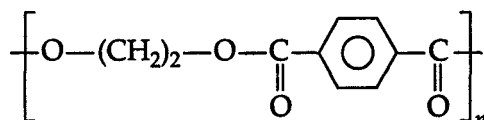

Aromatic polyester (melting point 265°C)

Thus the incorporation of the aromatic ring causes rise in melting point, and stiffening action of the polymer chain backbone. These properties make it good fibre-forming compound.

Polymerization : A polyester, polyethylene terephthalate, with the trade name 'Terylene' or 'Terene' was prepared by the reaction between terephthalic acid and ethylene glycol. First of all, the acid terephthalic is converted to the dimethyl ester, which can easily be purified by distillation or crystallization. This is then allowed to react with ethylene glycol by ester interchange as follows :

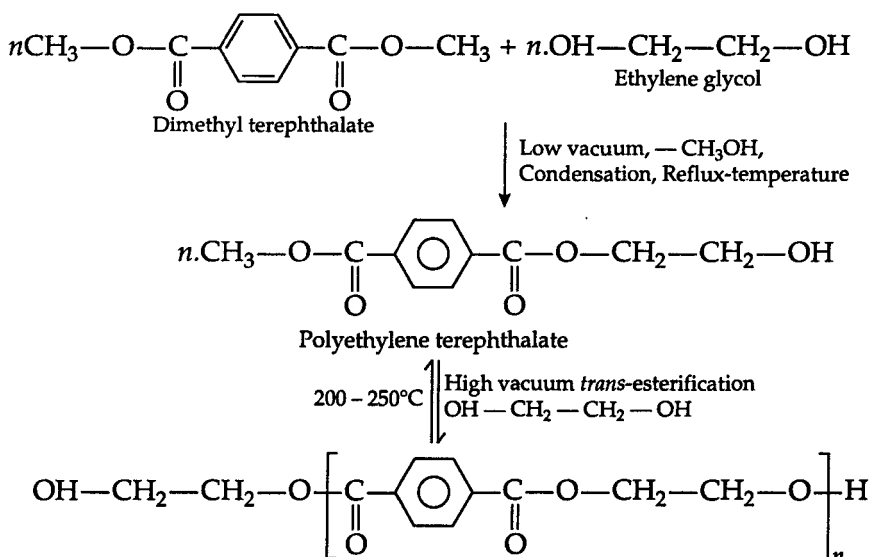

Aliphatic unsaturated polyester also finds some industrial importance. It is prepared between the reaction of an unsaturated dicarboxylic acid, *e.g.*, maleic acid, and ethylene glycol. The reaction is as follows :

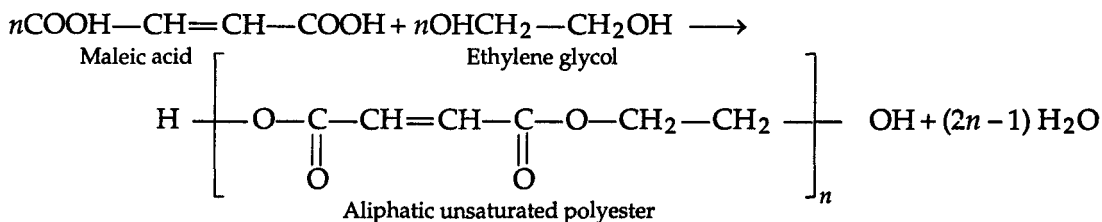

A double bond is present in the backbone on the polymer chain, which can be utilized to cross-link the resin with styrene using free radical catalysts. In fibre-reinforced plastic structures, the unsaturated polyester-styrene combination is present, which is used as the resin matrix. These resins are used in the coatings of decoratives.

Applications : The polyester fibres are much useful due to their outstanding crease resistance and low water absorption properties. The garments made from polyester fibres are quiet resistant to wrinkling and can be washed repeatedly without any ironing. Polyester fibres are rarely used alone, usually they are blended with cotton or wool to make summer- and medium-weight suiting and other apparels. They are famous for the wearing dress through the "wash and wear" concept.

Polyester fibres are also popular as a tire cord, with about 25% of the market for the last decade.

Polyester is also used in the preparation of films. The tensile strength of this polymer is about 25,000 psi, *i.e.*, two or three times that of cellulose acetate or cellophane film. The impact strength of this polymer is about three or four times of any other plastic film. The magnetic recording tapes are manufactured due to the toughness of polymer. For soft-drink use, polyethylene terephthalate has been developed the blown bottles.

Polybutylene terephthalate and various other copolymers also possess minor plastics use.

► PHENOLIC RESINS

Phenolic resins are the most important thermo-setting resins. Thermosetting resins are those which can change irreversibly in heat from a fusible and soluble material into one which is infusible and insoluble.

Phenol resins are formaldehyde condensation product with phenol. The polycondensation reactions are catalysed either by acids or bases, as follows :

Acid-Catalysed Polycondensation : This reaction proceeds in the presence of acid and produces mono- and dimethyl phenols.

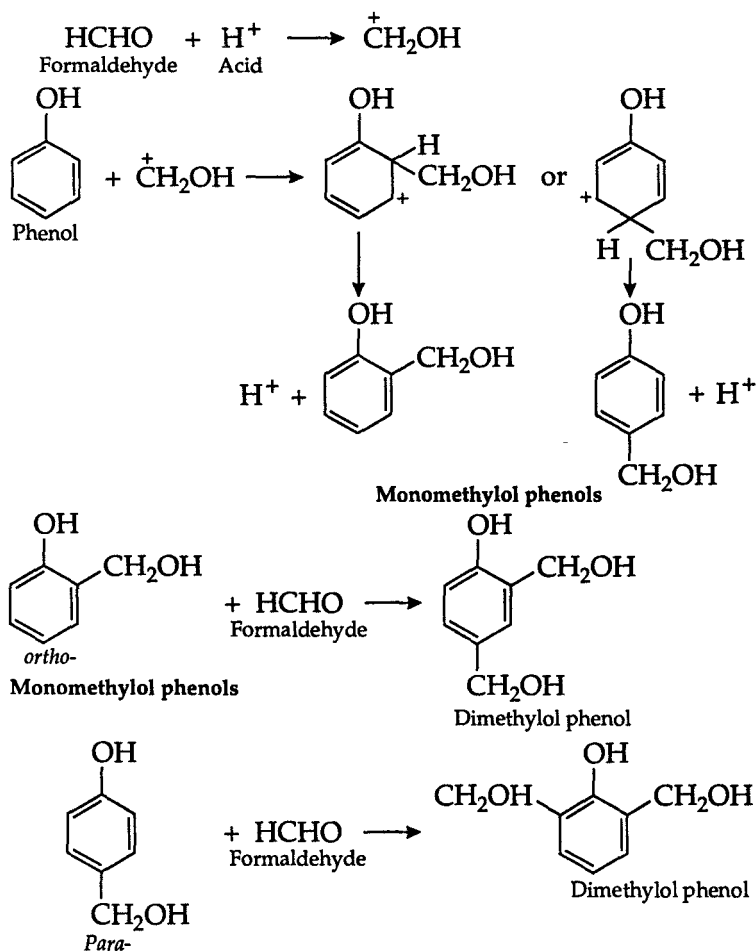

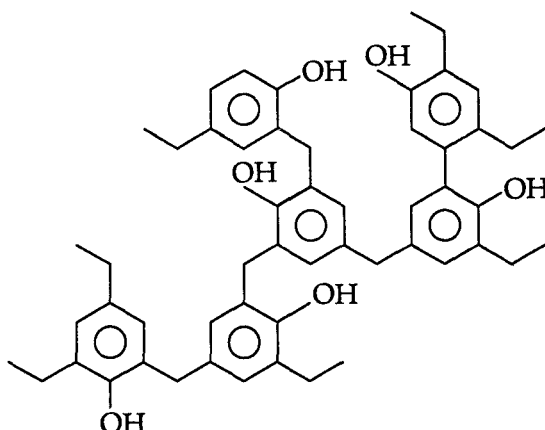

This reaction forms only linear molecules and can be carried out in two ways :

(a) Formation of Novlak or 'Bakelite' resins : In this case phenol is taken with 75% of the stoichiometric quantity of formaldehyde using an acid catalyst.

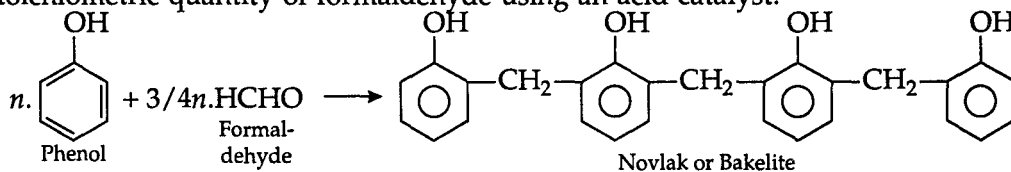

Thus, linear molecules of resin are formed, which does not become hard when stored for a long time. This product can be cross-linked by adding excess of formaldehyde and then heating it, such types of resins are called 'Novlak' or 'Bakelite' resins.

Formation of 'Resols' : In this process an equimolar amounts of formaldehyde and phenol are taken with alkali catalyst. The reaction forms a linear resin, which consists of the entire quantity of the methylol groups at ortho- and para-positions. On storage of this product, a slow reaction will continue which causes hardening of the resin. This type of resin contains a limited shelf life and called 'Resol' resin.

Properties and Applications : When phenolic resins are combined with fillers, they have good chemical and thermal resistance, dielectric strength and dimensional stability. The products made by this resin contain low moisture absorption, creep resistant and low flammability.

The major use of phenolic resins is in thermal setting adhesives for plywood.

For impregnating wood, paper and other fillers, about 8% of phenolic resins are produced, called laminating resins. These are used for decorative laminates for counter tops, wall covering, industrial laminates for electrical parts, printed circuits, shaped products, cutlery handles, and toilet seats. Various industrial applications are based on the excellent adhesive properties and bonding strength of the phenolic resins; these are sand papers, foundry molds, brake linings, and abrasive wheels.

The Bakelite resins are usually compounded with fillers such as asbestos powder or saw dust and are used for moulding electrical items, telephone instruments etc. The resols are also used with fabric or asbestos cloth and impregnated. Many layers of these impregnated materials are pressed under hydraulic press and heated at 150–160°C. Thus, a

single sheet of greater thickness is formed. The resols are also used for making laminates and applied as coating compositions.

♦ EPOXY RESINS

These are thermosetting resins. Basically, epoxy resins are polyethers, but they consist of epoxide groups in their structure before crosslinking, therefore, known by the name on the basis of their starting material.

Preparation : Epoxy resin is prepared from epichloro hydrin and bisphenol A. In place of bisphenol-A, various other hydroxyl group containing compounds can be taken, such as, hydroquinone, glycols, glycerols and resorcinols etc.

The epoxy resins obtained by this process will be either highly viscous liquids or solids with high melting points. It can be further cured with substances such as polyamides, amines and poly sulfides. The entire reaction scheme follows as :

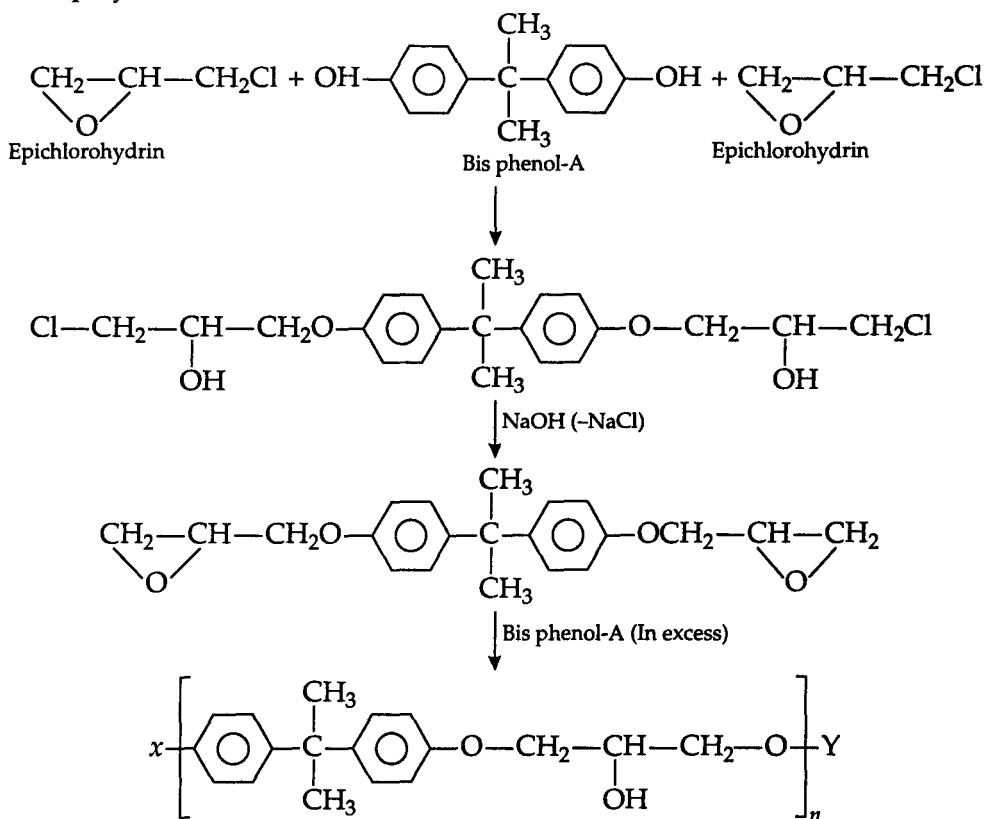

where

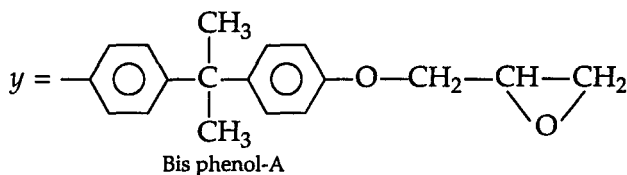
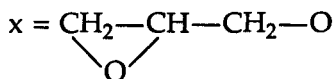

Instead of epichlorohydrin, several other compounds were tried, but no epoxides were found good even its attractive prices.

Properties and Applications

Epoxy resins have remarkable chemical resistance, good adhesion, toughness and flexibility. These polymers can be used in both, molding and laminating techniques to make glass fibre-reinforced articles with better mechanical strength, chemical resistance and insulating properties.

The important uses of epoxy resins are in industrial flooring, adhesives and solders, foams, stabilizer for vinyl resins, highway surfacing and patching materials, casting, potting, encapsulation in the electrical and tooling industries.

▶ SILICONE POLYMERS

Silicon consists of a valency 4 and comes in fourth group of the periodic table. Carbon is also a member of fourth group of periodic table like carbon, silicon has the capability of forming covalent compounds, *e.g.*, carbon combines with hydrogen to form CH_4 , similarly silicon combines with hydrogen to produce SiH_4 . But like carbon, silicon cannot form $\text{Si}=\text{Si}$ double bonds, therefore, the polymer of silicon can be formed by polycondensation. The $\text{Si}-\text{Si}$ bond is very unstable in the large molecules, hence, polymers of silanes are unknown. The polymer of silicones are found in the form of siloxane, as

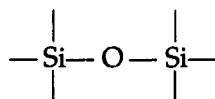

The siloxane linkage is more stable and found in commercial silicone polymers.

Polymerization : Silicone polymers are formed by alkyl chlorosilanes, or aryl chlorosilanes, of substituted esters of orthosilicic acid. These compounds form hydroxyl compound; silanol, on hydrolysis as follows :

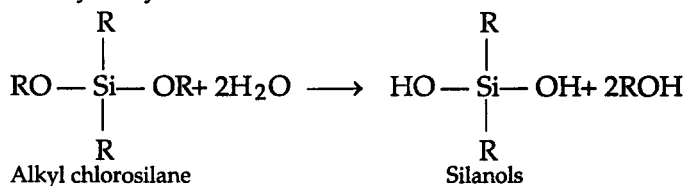

By condensation reactions, the silicone polymers are obtained from silanols as given below :

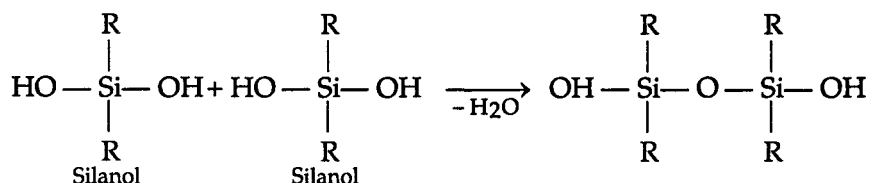

The process of polycondensation proceeds in the same way and forms silicone polymers.

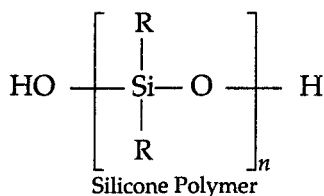

Properties : Silicone polymers are found in liquid, waxy or rubbery forms. They are thermally very stable. These polymers can stand against high temperature. Water repellency and chemical resistance is a good property of silicone polymers.

Uses : These polymers are useful in surface coatings and laminations. Light weight foams are made by silicone polymers for missiles and aeroplanes. They are also used primarily as insulating varnishes, impregnating and encapsulating agents, and in industrial paints. Further, silicone polymers are used as elastomers and can be vulcanised with the help of peroxide initiators.

To reinforce silicone rubbers, fine powdery form of silica is used as a filler. These reinforced silicone rubbers are quite flexible even at a low temperature, *i.e.*, -90°C and also at fairly high temperature, *i.e.*, $+150^{\circ}\text{C}$.

▶ ELECTRICALLY CONDUCTING POLYMERS

It is a fact that the organic polymers containing a carbon backbone are completely insulators of light. These polymers are generally used in coatings for cables and electrical wiring when a medium of high resistivity is needed. The resistivity of these polymers can be reduced if a composite of the polymer with carbon black or finely divided metal is fabricated. The conduction of electricity in these cases takes place through the filler and not via the organic polymer. The mechanical strength of polymer can also decrease by incorporating the filler substances.

A polymer polyacetylene is a very poor conductor in the pure state. When it is reacted with I_2 , it could be converted into a most conductive polymer. As conduction appears to be due to movement of electrons through the polymer. The result was surprisingly increase over 10^{10} in conductivity. This dramatic discovery has opened an exciting new dimensions in the field of synthetic metals. A lot of other polymers which are insulators in the pure form, can be converted into polymer salts when treated with an oxidising or reducing agent, they achieved electrical conductivities as comparable to metals.

Mechanism : The mechanism of conduction can be understood by the following manner :

The electrical conductivity is a function of the number of charge carriers of species i (n_i) the ε_i is the charge of each carrier, μ_i is the carrier mobilities, σ is the conductivity. The conductivity is described by the relation :

$$\sigma = \sum \mu_i \cdot n_i \cdot \varepsilon_i$$

where the units of conductivity are S cm^{-1} .

In the solid compounds, the conduction is usually explained by band theory. The band theory postulates that when atoms or molecules are aggregated in the solid state, the outer

atomic orbitals containing the valence electrons are split into bonding and antibonding orbitals, and mix to form two series of closely-spaced energy levels. These are generally called the valence band and the conduction band respectively. If the valence band is only partly filled by the available electrons, or if the two bands overlap so that no energy gap exists between them, then application of a potential will raise some of the electrons into empty levels where they will be free to move throughout the solid thereby producing a current. This is the entire mechanism of a conductor.

If, on the other hand, the valence band is full and is separated from the empty conduction band by an energy gap, then there can be no net flow of the electrons under the influence of an external field unless electrons are elevated (jumped) into the empty band and this will require an expenditure of energy. These types of materials are either semiconductors or insulators, depending on how large the energy gap may be, and the majority of polymers are insulators.

When we consider electronic conduction in polymers, band theory is not completely correct because the atoms are covalently bonded to one another, forming polymeric chains which experience weak intermolecular interactions. Thus macroscopic conduction will require electron movement, not only along chains but also from one chain to another.

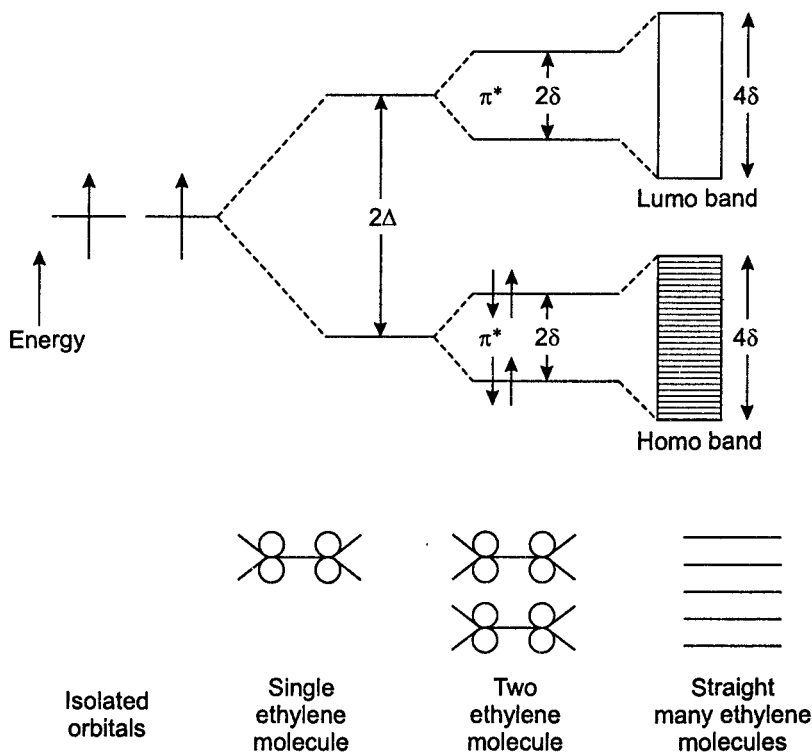

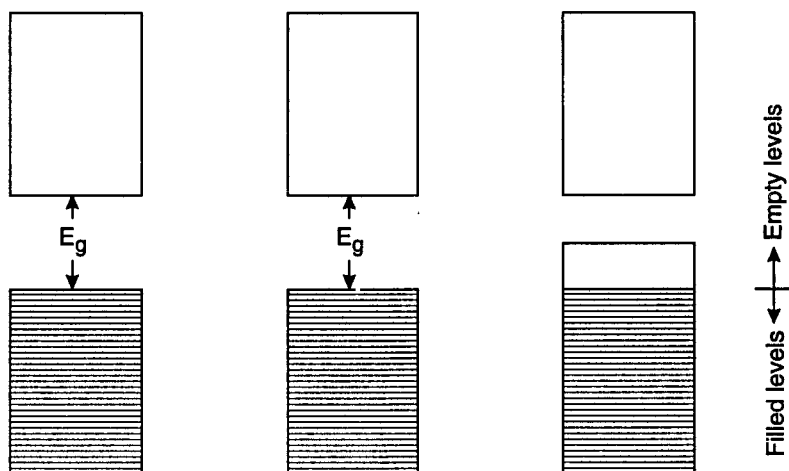

Fig. 1.

In the principle of band theory, the dark regions show the band filled with electrons, and the light regions the bands which are available for conduction. The energy gap between filled and empty states is E_g .

Preparation of Conductive Polymers

Structure and conductivity of the Doped conjugated polymers

Polymer	Structure	Methods of doping	Conductivity ($S\text{ cm}^{-1}$)
Polyacetylene		Electrochemical, chemical (I_2 , Li, K, AsF_5)	$500 - 1.5 \times 10^5$
Polyphenylene		Chemical (Li, K, AsF_5)	500
Polyphenylene sulphide		Chemical (AsF_5)	1
Polypyrrole		Electrochemical	600
Polythiophene		Electrochemical	100
Polyphenyl-quinolene		Electrochemical chemical (Sodium naphthalide)	50

Conducting polymers can be prepared either by oxidizing or reducing the polymer using a proper reagent. The band theory model could explain the increased conductivity as either removal of electrons from the valence band by the oxidizing agent leaving it with positive charge, or donation of an electron to the empty conduction band by a reducing agent. These processes are called *p*-type doping and *n*-type doping respectively.

The addition of a donor or acceptor molecule in the polymer is called 'doping'. During doping the reaction which occurred is a redox reaction and is unlike the doping of Si or Ge in semiconductor process where there is substitution of an atom in the lattice. The terminology in common use will be retained here but it should be remembered that the doping of conductive polymers involves the formation of a polymer salts, and this can be effected either by immersing the polymer in a solution of the reagent, or by electro-chemical methods.

Applications : Doped polymers can act as an electrode and can be used in rechargeable battery. These batteries represent a combination of electrical conductivity with the light weight corrosion resistant properties.

The conducting polymers may find use in electromagnetic shielding since they tend to absorb low frequency radiation or as parts of solar cells and semiconductors. Their use as heating elements in the thin-wall coverings, and in wire and cable applications are also being discovered.

These polymers have also been used in the manufacturing of wave guides.

♦ FUNCTIONAL POLYMERS

Functional polymers consist of chemical groups that serve a specific function whether biological, pharmacological, electrical or other.

Functional polymers are the polymers which contain advanced optic and/or electronic properties. They are microscopically small, highly effective and extremely flexible. Functional polymers consist of low cost, easier in processing, and have an attractive range of characteristic properties. One can adjust its properties by keeping material usage in low quantity. This open interesting environmental perspectives.

Polymer bound substances can spread their activity with endangering people or environment.

Few examples of functional polymers are :

- (a) Semiconductive conjugated polymers
- (b) Biomimetic materials
- (c) Supramolecular metallopolymers
- (d) Stimuli responsive polymers (these allow for responsive drug delivery systems and smart surfaces for cell culture and regenerative medicine).

Various metathesis processes produce a wide variety of functional polymers or oligomers. An excellent example of this is a dihydroxy telechelic polymer. These telechelic materials have several important and growing industrial applications including the production of multi-block polymers such as styrene-butadiene-styrene (Kraton) and thermoplastic polyurethanes. High quality telechelic materials are, however, notoriously

difficult or impossible to prepare by other methods. The reaction (given below) is an example of telechelic synthesis :

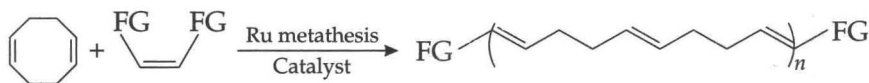

Uses : Functional polymers are to act as a catalyst, to bind selectively particular species, to capture and transfer electric charge or energy, to convert light into charge carriers and vice-versa, to transport immobilized drugs to a particular tissue cell in which a drug is released etc.

♦ FIRE-RETARDING POLYMERS

The presence of polymers is ubiquitous in everyday life. To minimize fire hazards, fire-retardant chemicals can be added to polymers as additives, because a concomitant hard associated with these materials is their combustibility. It is evidenced by fire-related deaths and property damage.

Past attempts to control pyrolytic propagation involved the use of additives or chemical modifications of the polymer.

The additives are usually added into polymer during processing. There are few elements which are usually known as fire-retardants :

Fire-retarding substances : The following substances are used as fire-retardants :

(a) Metal Hydroxides : The use of metal hydroxides as polymer additives increases fire-retardation properties mainly by means of endothermic dehydration. Sufficient fire proofing properties, call for high-loading of the additive thus effecting the mechanical properties of the polymer.

(b) Halogens : Halogen-containing polymers also contain fire-retardant properties by removing reactive radical species necessary for the pyrolytic reaction mechanism. Environmental as well as health concerns, however, have limited the use of halogenated fire retardants.

(c) Phosphorus : Integration of phosphorus into organic polymers can also enhance flame-retardant properties. Several condensed-phase mechanisms are proposed to be

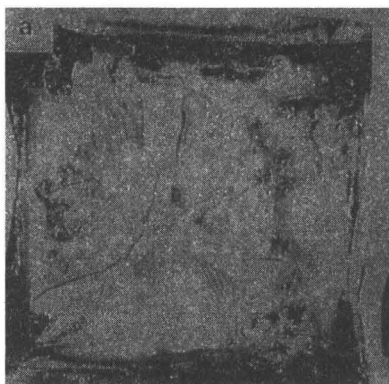

(a) Unphosphorylated

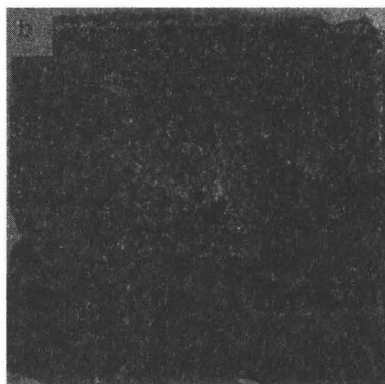

(b) Phosphorylated polymer resin

Fig. 2. Images of charred intumescent layer